



DEKOTOP

COMPACT PANEL

WWW.DEKORACIOGROUP.COM

COMPACT PANEL

DEKOTOP concern public's health, thus we strive to reduce toxic chemicals such as Formaldehyde in all of our production, improvement in the resin formula allows all laminates to meet E-0 & E-1 European formaldehyde emission standards. DEKOTOP Wear Resistant Compact Panel far exceeds the industry standards and dramatically durable. This enhancement of surface feature is available in variety of patterns and colours. DEKOTOP Fire-Retardant Compact Panel meets fire codes from a variety of laboratories in multiple countries especially certified by DNV. They are used in residential, commercial, industrial buildings and transport industries where safety regulations require strict compliance. DEKOTOP Compact Panel takes responsibility for the environment.

FEATURES



THERMAL
SELF HEALING

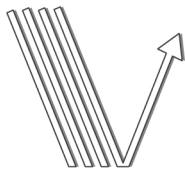

LOW LIGHT
REFLECTION



ANTI
FINGERPRINT



EASY TO
MAINTAIN

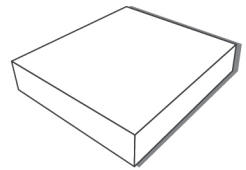

INTERIOR GRADE
COMPACT PANEL

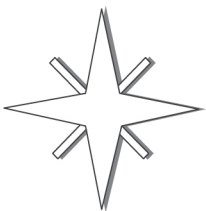

ULTRA MATTE
SURFACE



WATER
REPELLENT



SCUFF &
WEAR RESISTANT



ECO-FRIENDLY
(ECO)



FIRE-RETARDANT
(FR)

WOODGRAINS

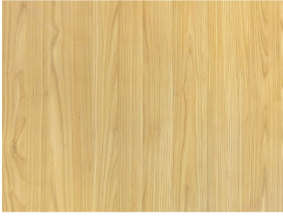

DT 023
GOLDEN CHERRY

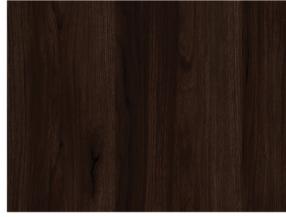

DT 032
OSLO OAK



DT 026
YOLK WALNUT



DT 037
DAVOS



DT 028
HERISAU



DT 035
OLTEN



DT 036
BREMEN

PATTERNS



DT 022
LIGHT CONCRETE



DT 025
GREY CONCRETE

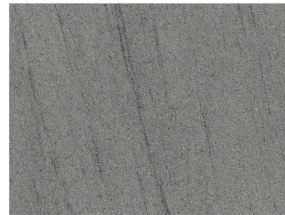

DT 033
CASERTA

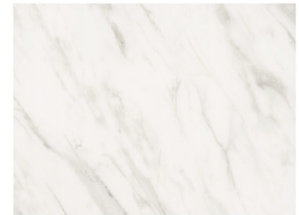

DT 038
MAKRANA MARBLE

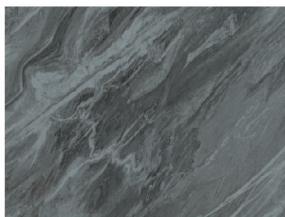

DT 029
MONZA MARBLE

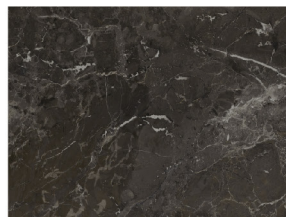

DT 027
IMOLA MARBLE



DT 031
SCAFATI MARBLE

CLEAN TOUCH



DT 017
CT CHARCOAL



DT 030
CT BURGUNDY

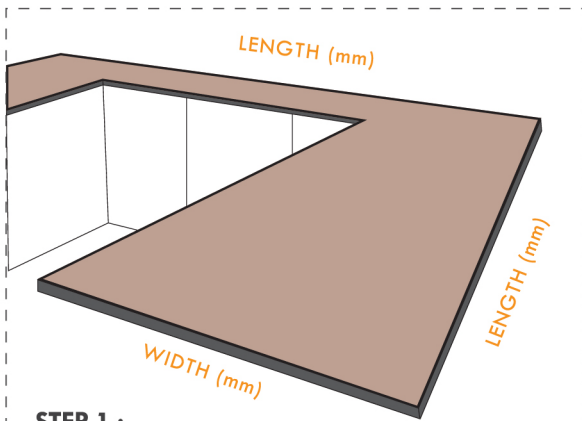

STEP 1 :
Measure the **LENGTH & WIDTH** of table top in millimetre (mm).
台面的长度和宽度须以毫米为测量单位。

1.MEASUREMENT 测量

PRECAUTIONS BEFORE MEASUREMENT:

测量前需要注意事项:

- To ensure Dekotop can be install in precision and accurately, the measurements will be taken on site while basin, stove and water tap allocated.
为确保 DEKOTOP 能精确地施工，水盆，炉灶与水龙头都必须预留在现场，以方便测量工作。
- Allocation of basin and stove hole have to be open in advance.
请确保水盆与炉灶洞口事先施工开槽。

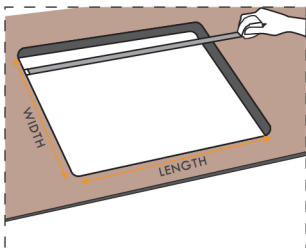

STEP 2 :
Determine the **length and width** of sink's hole.
确定水盆口之间的长度和宽度。

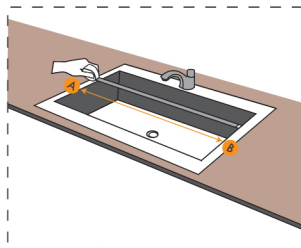

STEP 3 :
Determine the sink's length from side to side. (A to B)
确定水槽间隔长度。(A至B)

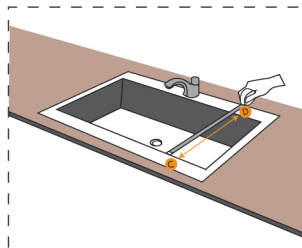

STEP 4 :
Determine the sink's width from front to back. (C to D)
确定水槽间隔宽度。(C至D)

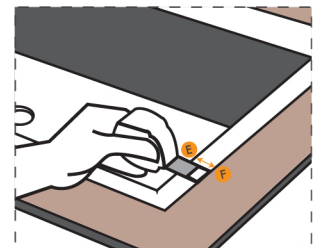

STEP 5 :
Measure the thickness of the top-mount sink (E to F)
测量水槽边的实际宽度。(E至F)

2.CUTTING 切割

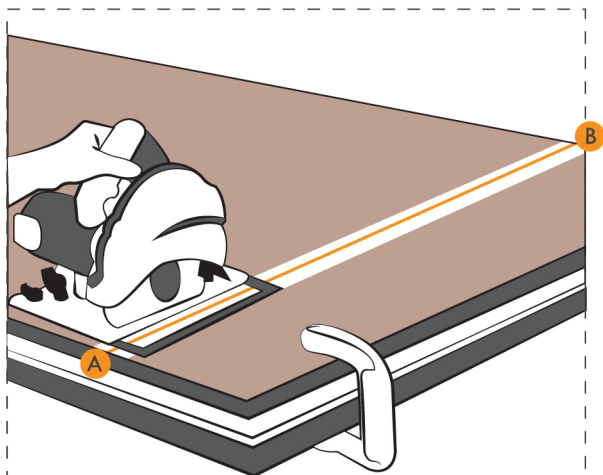

CIRCULAR SAW 电圆锯

Align the circular saw from the point A and cut slowly to point B.
将电圆锯放置在切割点 A 并沿着切割线缓慢切割至 B。

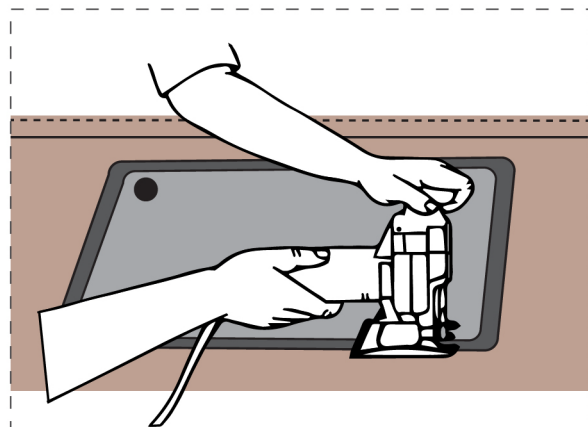

ELECTRIC JIGSAW 跳锯

Crop out the basin and hob by using the electric jigsaw.
依次使用跳锯裁切出水盆与炉灶的洞口

PRECAUTIONS BEFORE CUTTING 切割前需要注意事项:

- Stainless steel jigsaw with diamond blade is highly recommended. 建议使用白钢制钻石锯片。

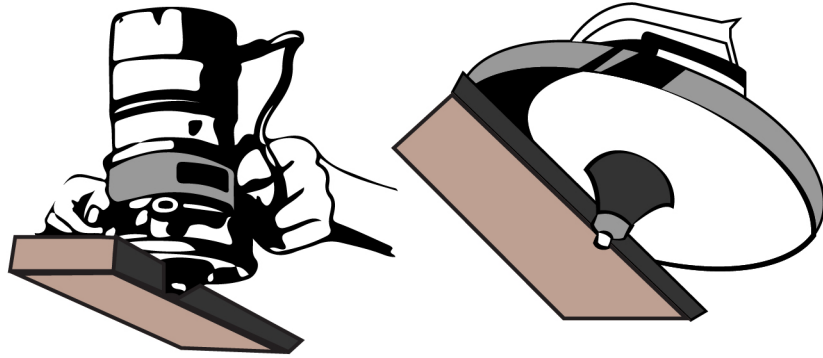

ROUTER TRIMMER 木工雕刻机

3.CHAMFERED / TRIMMING 抛光

Apply Router Trimmer to polish the edge.

为了安全与美观考量，使用木工雕刻机在见光面部分进行加工抛光。

4.POLISH 磨边

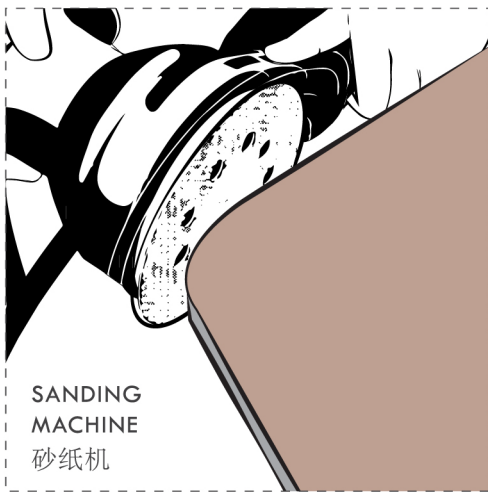

SANDING MACHINE
砂纸机

Use a Sanding Machine to smooth the edges of the compact panel.

使用细砂纸机轻轻地在切割与见光面进行打磨。

5.STICK 粘合

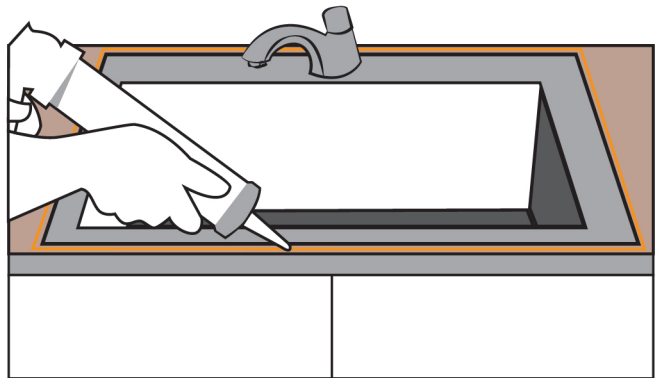

STEP 1 :

Application of “#” Method is compulsory.

运用“#”字粘法将粘接剂均匀地涂上。

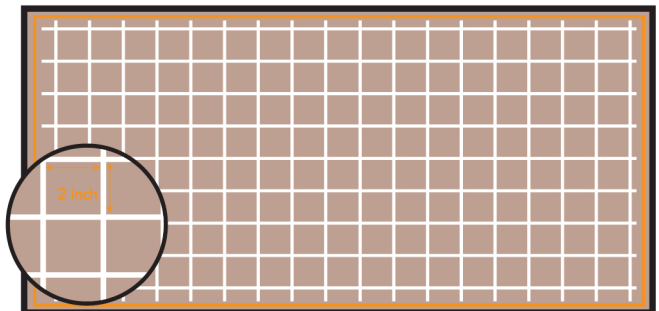

Maxbond

White Silicone (Claybase)

STEP 2 :

Apply transparent silicone along the edge of the basin before installation.

在安装台面前，在水槽周围涂上透明粘合剂。



Transparent Silicone

JOINT 接口

SURFACE JOINT

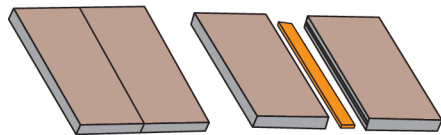

90° JOINT

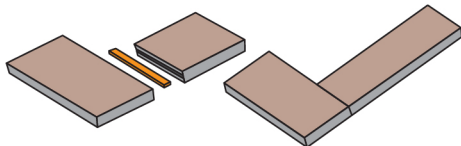

45° JOINT

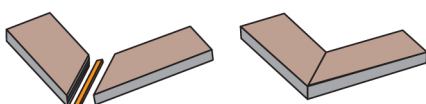



HEADQUARTER

NO.8 & 10, JALAN BISTARI 11, TAMAN INDUSTRI JAYA, 81300 SKUDAI, JOHOR.

TEL: +607-571 2060 / +6016-718 2980 FAX: +607-511 3080

BRANCH

**NO.3, LATITUDE JALAN SUBANG 7, TAMAN PERINDUSTRIAN USJ1,
47600 SUBANG JAYA, SELANGOR.**

TEL: +603-5888 9190 FAX: +603-5611 9190